



Look book

side tables

bars

kids

home office

media

shelves

wardrobes

100 furniture configurations

from an infinite number of possibilities.

Side tables

Bars

Kids

Home office

Media

Shelves

Wardrobes



1a
L/D/H: 1500/750/370 mm

1b
W/D/H: 773/373/230 mm

2
W/D/H: 723/723/390 mm

3
W/D/H: 773/523/430 mm

Side tables

4



5



6



Small items
can be elegantly
stored in a
narrow drawer.

7



4
W/D/H: 1023/1023/390 mm

5
W/D/H: 623/523/390 mm

6
W/D/H: 1223/773/390 mm

7
W/D/H: 1168/523/430 mm

Side tables



10
W/D/H: 1023/523/430 mm

11a
W/D/H: 523/523/490 mm

11b
W/D/H: 523/523/390 mm

8
W/D/H: 1023/723/390 mm

9
W/D/H: 1523/523/465 mm

Side tables

12



13

Incorporating plant and glass elements creates a particularly unique look.



14

12
W/D/H: 873/523/390 mm

13
W/D/H: 1373/773/490 mm

14
W/D/H: 523/373/465 mm

Side tables



15

16



17



15

W/D/H: 1773/373/1040 mm

16

W/D/H: 773/373/885 mm

17

W/D/H: 773/373/680 mm

Bars

18 



19



20

The handle can also serve as a hanging option.

21



18 
W/D/H: 2273/373/1865 mm

20
W/D/H: 523/373/630 mm

19
W/D/H: 2273/523/890 mm

21
W/D/H: 1523/373/1240 mm

Bars

23



22



24💡



USM Haller
is accessible from
all sides.

25



22
W/D/H: 773/723/780 mm

23
W/D/H: 523/373/780 mm

24💡
W/D/H: 418/373/1385 mm

25
W/D/H: 2273/623/1110 mm

Bars

Castors
transform furniture
into a mobile bar.

26



27



28 



26
W/D/H: 873/523/978 mm

27
W/D/H: 773/523/740 mm

28 
W/D/H: 2273/373/740 mm

Bars



29



30

A third dimension
invites you to
play and explore.



31

29
W/D/H: 1773/373/1130 mm

30
W/D/H: 1073/1073/1090 mm
31
W/D/H: 1448/373/915 mm

Kids



32



33



34



35

32
W/D/H: 1273/523/430 mm

33
W/D/H: 2273/723/740 mm

34
W/D/H: 1023/523/1030 mm

35
W/D/H: 1273/773/1490 mm

Kids

36



37



38



39



40



36
W/D/H: 1168/523/1140 mm

37
W/D/H: 723/723/1090 mm

38
W/D/H: 2023/373/790 mm

39
W/D/H: 1523/523/990 mm

40
W/D/H: 2523/373/740 mm

Kids

Our furniture is designed to be forever reconfigured.

Thanks to the high-quality finish and clever design, all components can be exchanged and extended at any time without any problems. This leads to limitless creative freedom, more individuality in design and almost infinite cycles of use.

think
value
re
design

41



USM furniture is a valuable companion for life, across generations.



42



41
W/D/H: 773/523/915 mm

42
W/D/H: 2023/523/915 mm



43

The USM KITOS M desk can be mechanically height adjusted without the need for electricity.



44a💡

44b

43
W/D/H: 1473/523/780 mm

44a💡
W/D/H: 2873/1973/1690 mm
44b
L/D/H: 1750/750/700-1200 mm

Home office



A drop-down door transforms furniture into a temporary desk.



45💡
W/D/H: 2273/623/1090 mm

47
W/D/H: 1168/373/1390 mm

46
W/D/H: 1623/1273/740 mm

48
W/D/H: 2123/523/1265 mm

Home office



49
W/D/H: 1523/373/1090 mm

51💡
W/D/H: 1123/1023/1440 mm

50💡
W/D/H: 2973/1373/1340 mm

52
W/D/H: 1123/523/1790 mm

Home office



53



54a

54b



55a

55b



56

53
W/D/H: 1523/373/1090 mm

54a
W/D/H: 2873/373/1790 mm

54b
L/D/H: 1250/500/740 mm

55a
L/D/H: 2000/750/740 mm

55b
W/D/H: 773/373/740 mm

56
W/D/H: 1918/523/780 mm

Home office



57

58



59



60



58
W/D/H: 3123/373/1765 mm

59
W/D/H: 2273/373/680 mm

57
W/D/H: 2273/373/2140 mm

60
W/D/H: 1473/373/565 mm

Media

61



62



63 



64 



61
W/D/H: 1973/373/740 mm

63 
W/D/H: 2273/373/540 mm

62
W/D/H: 2023/523/990 mm

64 
W/D/H: 4123/373/1790 mm

Media

66



65



A lowboard offers ample wall space for a large screen or art.

67



68



69



65
W/D/H: 1552/523/415 mm

66
W/D/H: 1773/523/1090 mm

67
W/D/H: 2273/523/390 mm

68
W/D/H: 2523/373/2015 mm

69
W/D/H: 1623/373/540 mm

Media

Our furniture is designed to be forever reconfigured.

Thanks to the high-quality finish and clever design, all components can be exchanged and extended at any time without any problems. This leads to limitless creative freedom, more individuality in design and almost infinite cycles of use.

think
re
design
value



70



71



72

70
W/D/H: 2273/373/565 mm

71
W/D/H: 1773/373/915 mm

72
WDH: 1773/373/1615 mm

73

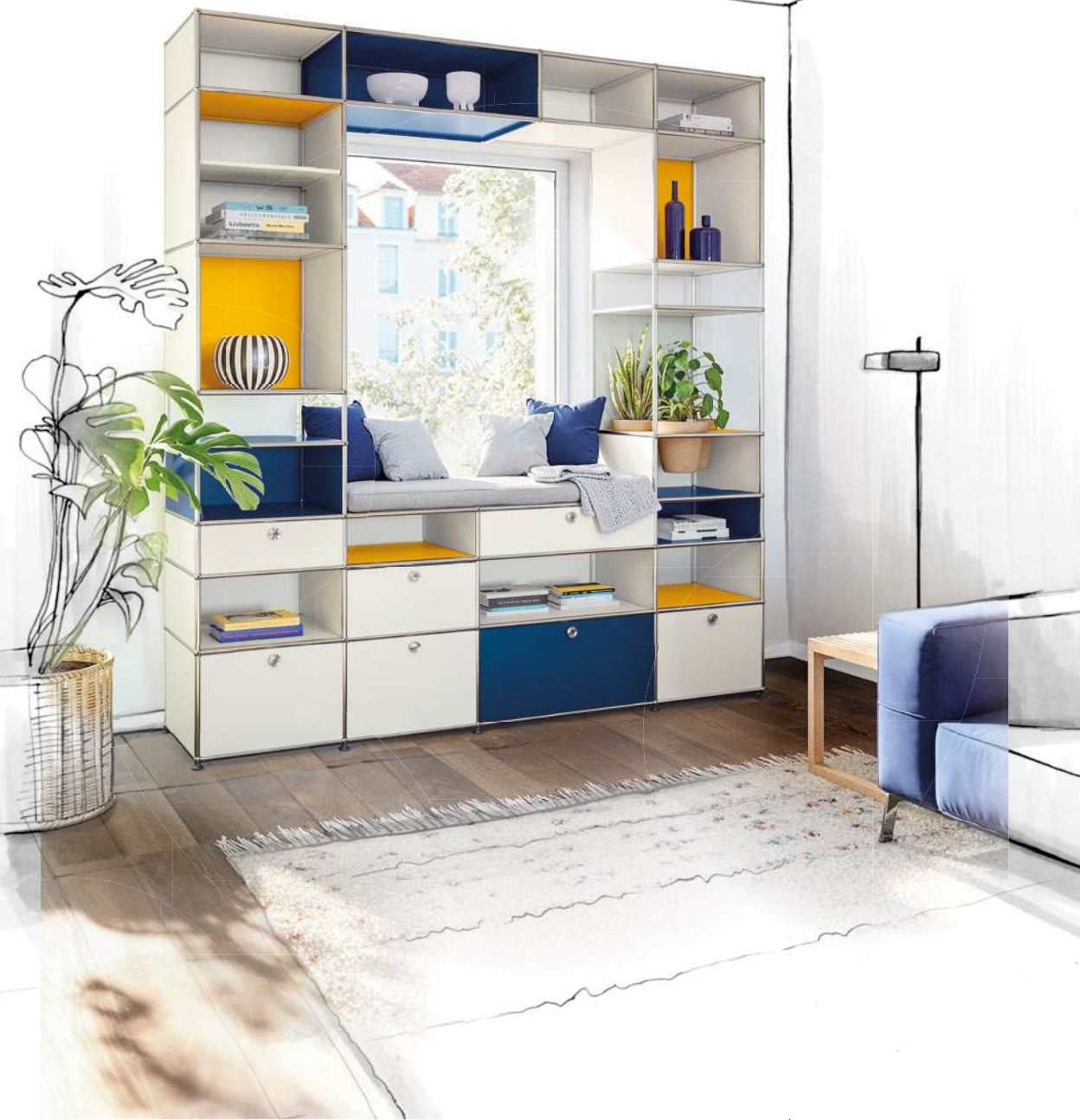

74 



75



73
W/D/H: 2273/523/2490 mm

74 
W/D/H: 1023/373/1765 mm

75
W/D/H: 2023/373/1665 mm

Shelves

76



77



78



79



A shelf height of
250 mm is ideal
for your collection
of novels.

76
W/D/H: 1523/373/2340 mm

77
W/D/H: 1523/373/1940 mm

78
W/D/H: 4523/373/1840 mm

79
W/D/H: 2523/523/1915 mm

Shelves

80



81 

82



83



80
W/D/H: 1773/373/1790 mm

82
W/D/H: 2273/1473/1940 mm

81 
W/D/H: 3023/273/1990 mm

83
W/D/H: 2273/373/1440 mm

Shelves

84



85



Open and closed compartments create a playful look.

86 



84
W/D/H: 2023/273/1790 mm

85
W/D/H: 1373/523/1840 mm

86 
W/D/H: 3723/373/1590 mm

Shelves

87 



88



89



87 
W/D/H: 523/523/1540 mm

88
W/D/H: 1523/723/1830 mm

89
W/D/H: 3023/523/2015 mm

Wardrobes



90

91 



92

Hangars fit wonderfully into 500 mm deep furniture.



93

90
W/D/H: 3023/523/2040 mm

91 
W/D/H: 1273/523/1790 mm

92
W/D/H: 1773/373/990 mm

93
W/D/H: 3773/523/2140 mm

Wardrobes



94💡



95

The side opening allows for space-saving wardrobes.



96



97

94💡
W/D/H: 3023/373/1690 mm

96
W/D/H: 873/273/1440 mm

95
W/D/H: 2273/723/1640 mm

97
W/D/H: 1023/373/965 mm

Wardrobes



98



99a

99b

Add low compartments to be used as seating thanks to hidden supports.

100



98
W/D/H: 3023/523/2140 mm

99a
W/D/H: 3273/2273/2040 mm

99b
W/D/H: 673/373/755 mm

100
W/D/H: 2873/373/2040 mm

Wardrobes



1



2



3



4



5

1 Metal magnetic bookend

Available in pure white and graphite black.

2 Pivoting pen holder

Provides room for writing instruments and can be discreetly stowed under the tabletop.

3 USM Inos internal organisation

Plastic inserts in metal trays are ideal for storing small bits and pieces, whether in the home office or in the house.

4 USM Inos drawer set

Thanks to its dimensions it fits into any piece of USM furniture. The displayed set with 5 closed drawers is available in all 14 USM colours. The drawer sets with 5 open, 10 open or 10 closed drawers are available in graphite black and pure white.

5 World of plants for USM Haller

Lively evergreen landscapes can now be easily integrated into the structure of USM Haller.

6 USM Inos Box

The new USM Inos Boxes organise, store and protect both your treasures and everyday bits and pieces. Several boxes can be stacked on top of each other with the help of trays, which can also be used as covers or serving trays, or to hold assorted small items around the home. These soft storage boxes made of nonwoven polyester are available in four different sizes and in light grey and anthracite.

7 USM Haller E

A modular structure of your design, either completely or partially equipped with e-Balls and e-Tubes, is connected to a source of electricity. The structure itself conducts the low voltage electricity to the desired location using the e-Balls, e-Connectors and e-Tubes to form a circuit. USB chargers or light sources can be snapped into place in pre-cut recesses.



7



6

Accessories

USM Haller



Metal



Pure white
RAL 9010



Light grey
RAL 7035



USM mid-grey



Anthracite
RAL 7016



Graphite black
RAL 9011



Steel blue
RAL 5011



Gentian blue
RAL 5010



USM green



Golden yellow
RAL 1004



Pure orange
RAL 2004



USM ruby red



USM brown



USM beige



Olive green
RAL 6003

USM Haller and USM Kitos tables



Powder-coated MDF



Pure white
RAL 9010

Trans-parent glass



Transparent glass

Linoleum



Ash linoleum



Charcoal linoleum



Black linoleum



Pebble linoleum

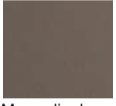

Mauve linoleum

Laminate



Pearl grey laminate



Pastel grey laminate



Light mid-grey laminate



Dark warm grey laminate

Fenix



Fenix,
Bianco Kos

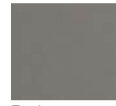

Fenix,
Grigio Londra



Fenix,
Nero Ingo

Oiled or lacquered veneer

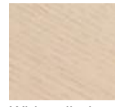

White oiled oak veneer



Natural oiled oak veneer

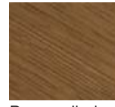

Brown oiled oak veneer



Natural lacquered oak veneer



Natural lacquered beech veneer

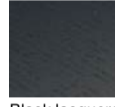

Black lacquered oak veneer

USM Inos box



Fabric panel



Light grey



Anthracite

Pots



Clay



Terracotta



Basalt

Details

USM Haller



Metal

USM Haller table

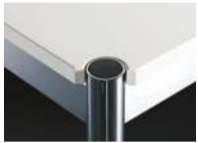

Powder-coated MDF

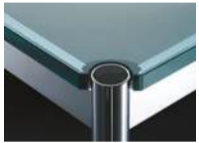

Transparent glass



Linoleum



Laminate



Fenix



Oiled or lacquered veneer

USM Kitos table



Powder-coated MDF



Linoleum



Laminate



Fenix



Oiled or lacquered veneer

Other colours and surfaces available upon request.

Prices and delivery times of table surfaces upon request.

The tabletop in glass is only available for USM Haller tables up to L: 2000mm.

Colours & surfaces

The USM Haller system provides a wide variety of elements in standard sizes. Widths, depths and heights are indicated below. All measurements refer to the distance between axes.



Your safety matters to us.
Check out the USM
safety instructions now.
www.usm.com/safety

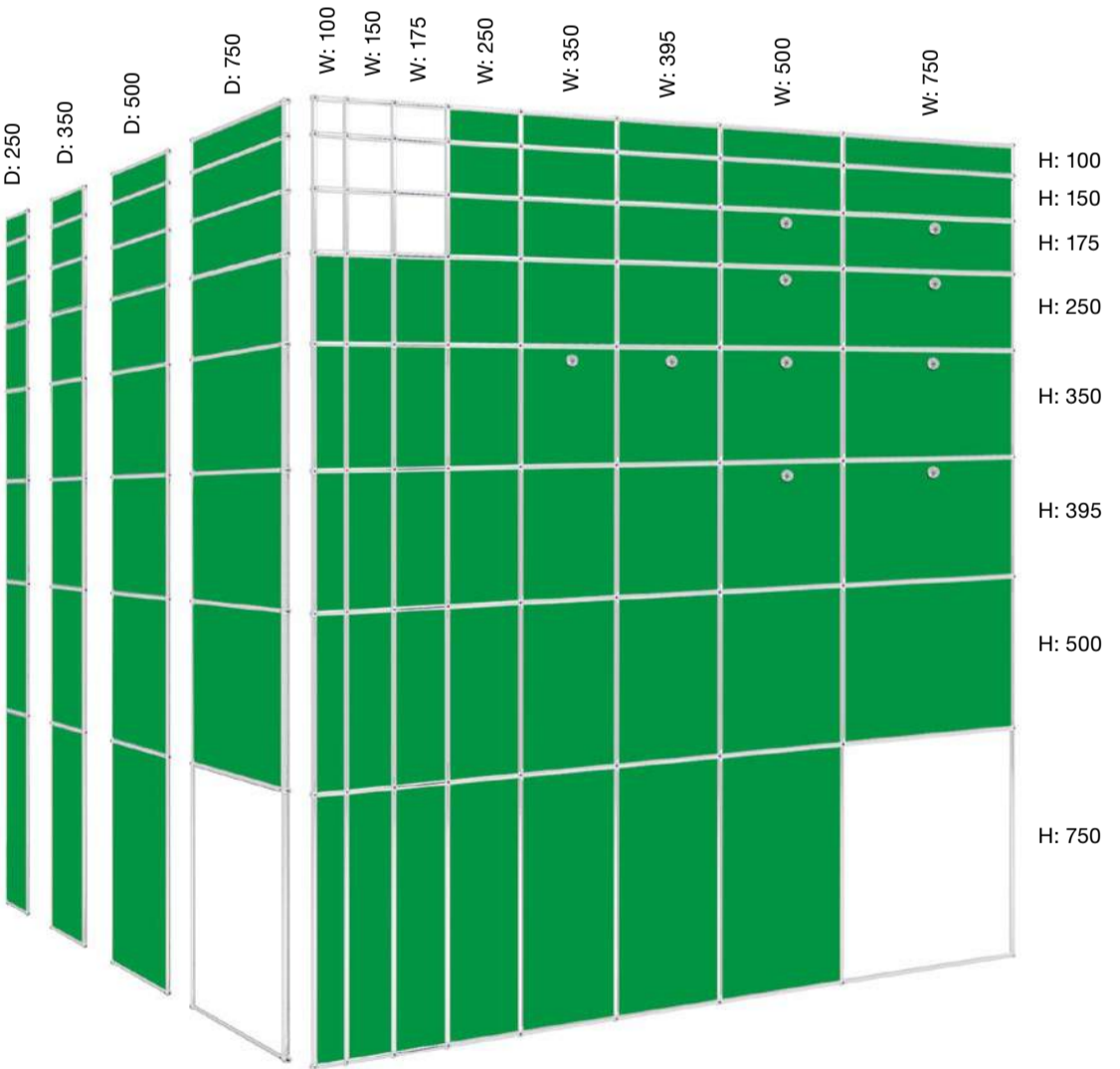
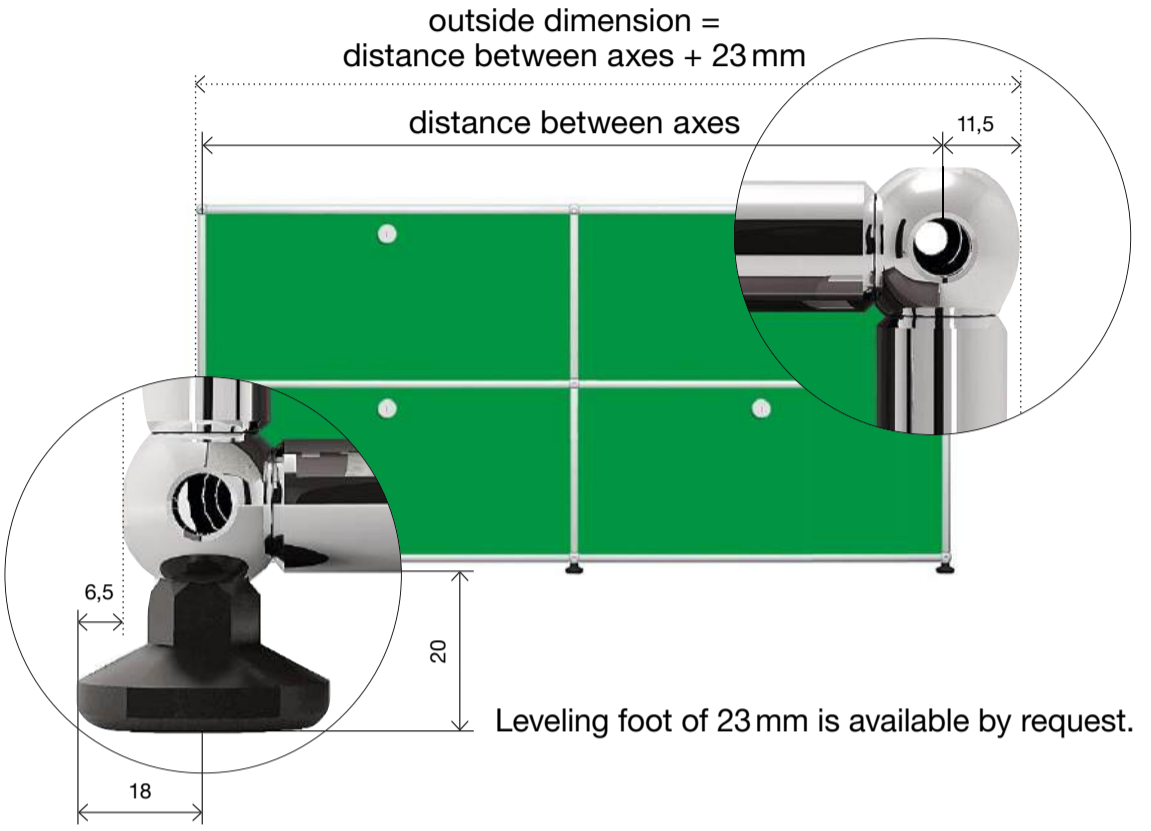

All measurements in mm.

USM Haller

Side tables



Bars



Kids

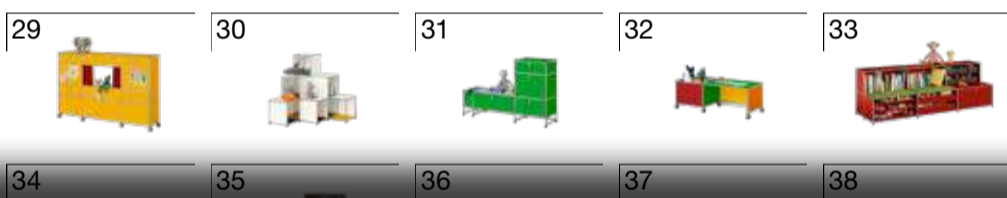

Side tables



Bars



Kids



Home office



Media



Shelves

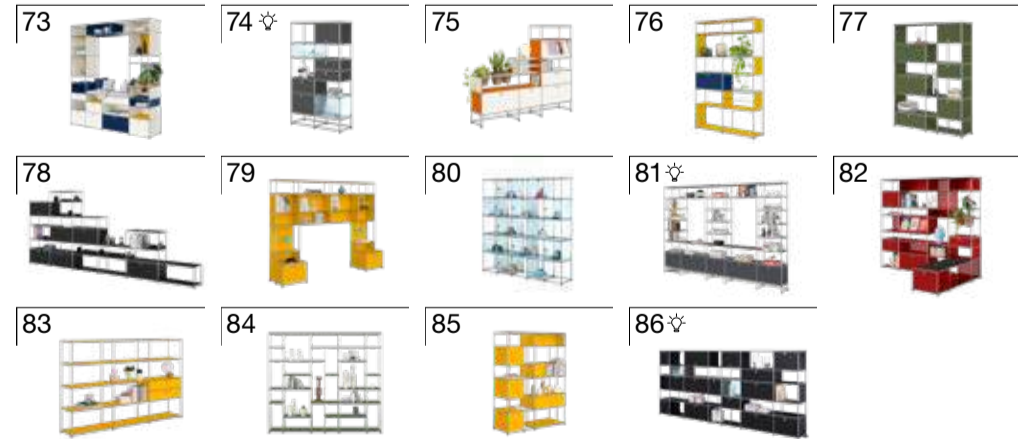

Wardrobes



Price list

